

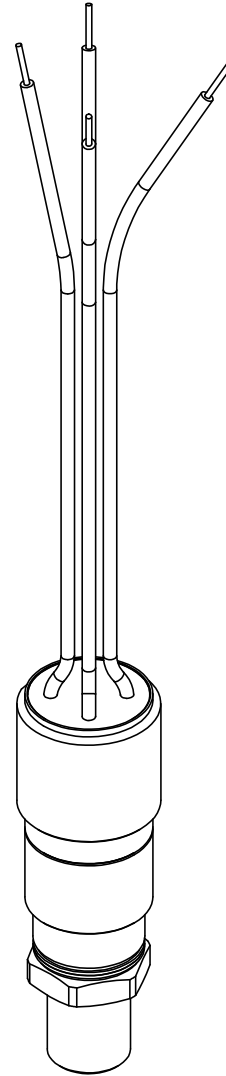

This drawing includes confidential information which is the property of ASHCROFT INC. This copy is loaned for a specific purpose, with the understanding that it will not be reproduced or used for any other purpose or disclosed to others, and it will be returned on demand.

ASHCROFT INC.

250 EAST MAIN STREET
STRATFORD, CT 06614

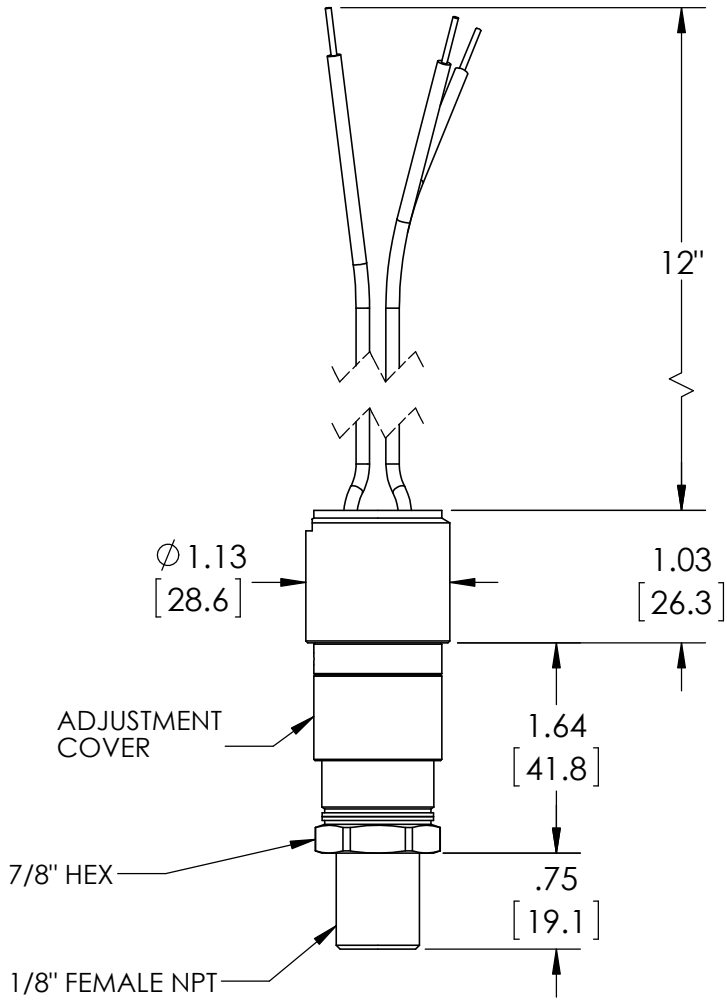

DIMENSIONS IN [] ARE MILLIMETERS

| REV. | ECO | DESCRIPTION | BY | DATE |
|------|---------|------------------------|-----|-----------|
| A | 0005029 | RELEASED GENERAL DIMS. | MJS | 7/14/2011 |

| This print certified correct for | | General Dimensions | | | |
|----------------------------------|------|-----------------------------------|--------------|----------------|----------|
| Customer's Name | | A-SERIES SWITCH APAN41H012L_03 | | | |
| Customer's Order No. | | Drawn MJS | Date 7/14/11 | Date of Issue | |
| Ashcroft Order No. | | Checked | Date | SHEET-1 | Rev. |
| Certified by | Date | Approved | Date | 70A3609 | A |